

# Kanalfläktar HGT, HGT-X



Kanalfäktar med stor diameter 1250, 1400 eller 1600 mm vid ventilation av stora luftmängder. Motorerna upp till 5,5 HP är på 230/400V, 50Hz. Motorer över 5,5 HP är på 400/690V 50Hz. Skyddsklass IP 55, isolationsklass F. Fläkthus i förstärkt valsad stålplåt med antikorrosiv värmebeständig epoxilack. Kort eller långt hus. Långt hus är försedd med motor inspektionsslucka. Finns med 3, 6 eller 9 aluminiumblad med inställbar vinkel. HGTX med remdrift och en max. lufttransporttemperatur på +120°C. HGTX finns bara med 1250 mm diameter. I nedan tabell har vi angivit flöde och tryck på fläkt med starkast motor, totalt finns det 54st HGT-125 fläktar, 37st HGT-140 fläktar och 43st HGT-160 fläktar. På begäran: Omvänt luftflöde, med reversibla vingar, i Ex-utförande EEx-e eller EEx-d, för brandgasutsug +400°C/2h eller 200°C/2h.



<b>HGT</b>	<b>125</b>	<b>4</b>	<b>T</b>	/	<b>3</b>	<b>22°</b>	<b>25</b>
Fläkttyp	Diameter (cm)	Poler	Trefas		Antal vingar	Grad på vingarna	Motor (HP)

## Teknisk data

Typ	Max.flöde m³/h	Max.tryck Pa	Ex.arb.punkt m³/h - Pa	Verkn. grad	Max.effekt kW		Varvtal r/min	Ljud dB (A)	Vikt kort hus kg		Vikt långt hus kg	
					min	max			min	max	min	max
HGT-125-4T/3	131500	450	90000 - 400	80%	7,5	45	1480	95	178	433	211	489
HGT-125-4T/6	155000	900	100000 - 800	76%	15	75	1480	96	249	548	277	598
HGT-125-4T/9	163000	1100	120000 - 850	72%	18,5	75	1480	99	306	557	349	607
HGT-125-6T/3	88500	200	62000 - 170	80%	3	15	970	85	171	315	207	358
HGT-125-6T/6	102000	400	70000 - 300	78%	4	18,5	985	84	185	365	218	409
HGT-125-6T/9	109500	500	80000 - 350	72%	7,5	22	980	87	252	394	280	438
HGT-125-8T/3	67200	110	45000 - 100	80%	2,2	5,5	710	75	176	234	209	262
HGT-125-8T/6	78500	225	50000 - 185	78%	2,2	7,5	715	75	185	273	218	301
HGT-125-8T/9	87000	240	65000 - 160	74%	3	11	720	79	201	329	234	372
HGT-140-6T/3	111000	220	80000 - 200	76%	3	15	970	88	214	364	251	414
HGT-140-6T/6	131000	325	80000 - 300	76%	4	22	980	89	231	437	268	486
HGT-140-6T/9	148000	450	100000 - 400	70%	7,5	37	985	92	300	568	339	623
HGT-140-8T/3	85500	125	60000 - 115	76%	2,2	7,5	715	82	221	311	258	350
HGT-140-8T/6	94000	180	62000 - 160	76%	2,2	11	720	83	231	321	268	360
HGT-140-8T/9	111000	250	75000 - 220	70%	3	15	740	86	370	437	419	485
HGT-160-6T/3	150000	270	115000 - 220	75%	4	22	980	89	275	493	327	563
HGT-160-6T/6	174000	440	120000 - 400	74%	7,5	37	985	91	350	629	404	714
HGT-160-6T/9	202000	570	120000 - 500	70%	11	75	990	93	374	903	428	1002
HGT-160-8T/3	110000	150	85000 - 120	75%	2,2	11	720	83	275	427	327	496
HGT-160-8T/6	130000	250	90000 - 220	74%	3	18,5	730	84	292	542	344	641
HGT-160-8T/9	151000	320	100000 - 290	67%	5,5	30	735	86	360	640	414	724

I ovan tabell har vi angivit flöde och tryck på fläkt med starkast motor. Kontakta oss för mer information.

## Mått (mm)

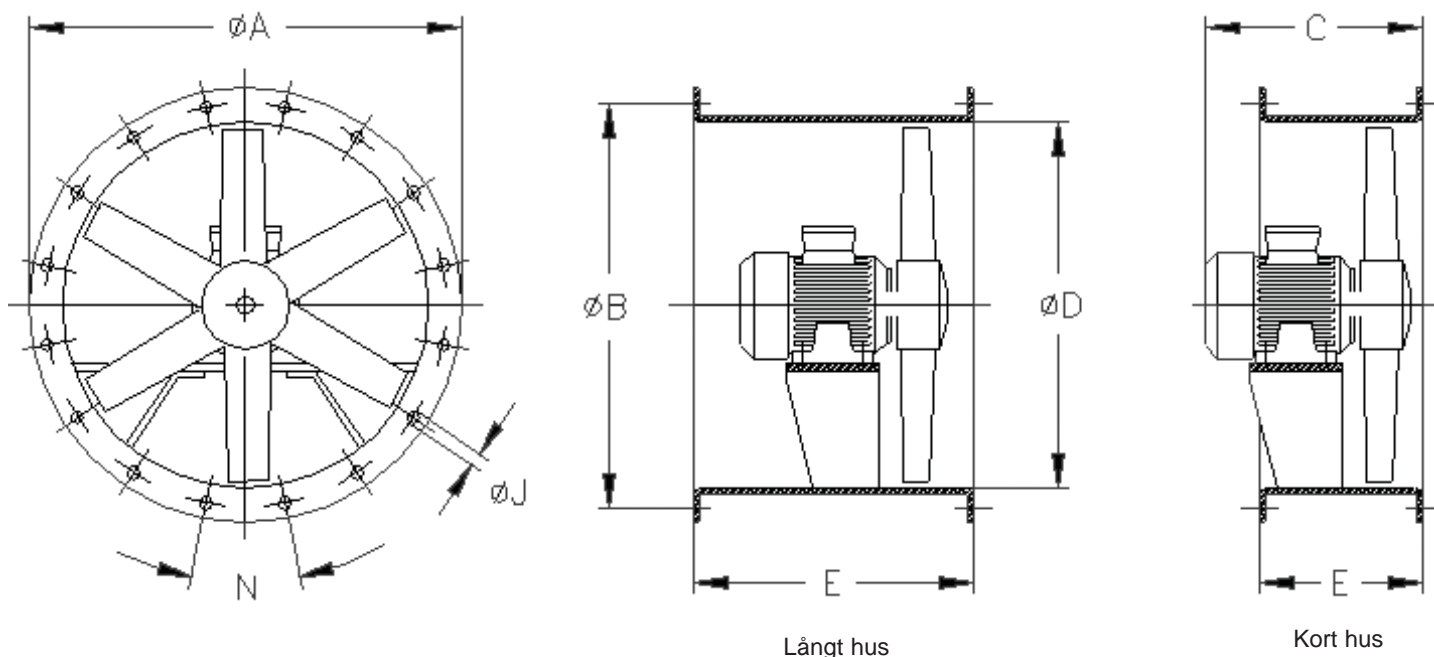

Vi förbehåller oss rätten till ändringar utan föregående meddelande.

# Kanalfläktar HGT, HGT-X



## Mått (mm)

Typ	Ø A	Ø B	C (kolla motor storlek)							Ø D	E		Ø J	N
			132	160	180	200	225	250	280		kort	lång		
HGT-125	1365	1320	570	-	-	-	-	-	-	1250	700	500	15	20x18°
HGT-125	1365	1320	-	700	-	-	-	-	-	1250	700	500	15	20x18°
HGT-125	1365	1320	-	-	765	825	-	-	-	1250	900	500	15	20x18°
HGT-125	1365	1320	-	-	-	-	910	-	-	1250	1000	500	15	20x18°
HGT-125	1365	1320	-	-	-	-	-	985	-	1250	1000	600	15	20x18°
HGT-140	1515	1470	570	-	-	-	-	-	-	1400	650	400	15	20x18°
HGT-140	1515	1470	-	700	-	-	-	-	-	1400	700	450	15	20x18°
HGT-140	1515	1470	-	-	765	825	-	-	-	1400	900	550	15	20x18°
HGT-140	1515	1470	-	-	-	-	910	-	-	1400	1000	550	15	20x18°
HGT-140	1515	1470	-	-	-	-	-	985	-	1400	1000	600	15	20x18°
HGT-160	1735	1680	570	-	-	-	-	-	-	1600	650	400	19	24x15°
HGT-160	1735	1680	-	700	-	-	-	-	-	1600	700	450	19	24x15°
HGT-160	1735	1680	-	-	765	825	-	-	-	1600	900	550	19	24x15°
HGT-160	1735	1680	-	-	-	-	910	-	-	1600	1000	550	19	24x15°
HGT-160	1735	1680	-	-	-	-	-	985	-	1600	1000	600	19	24x15°
HGT-160	1735	1680	-	-	-	-	-	-	1190	1600	1200	700	19	24x15°

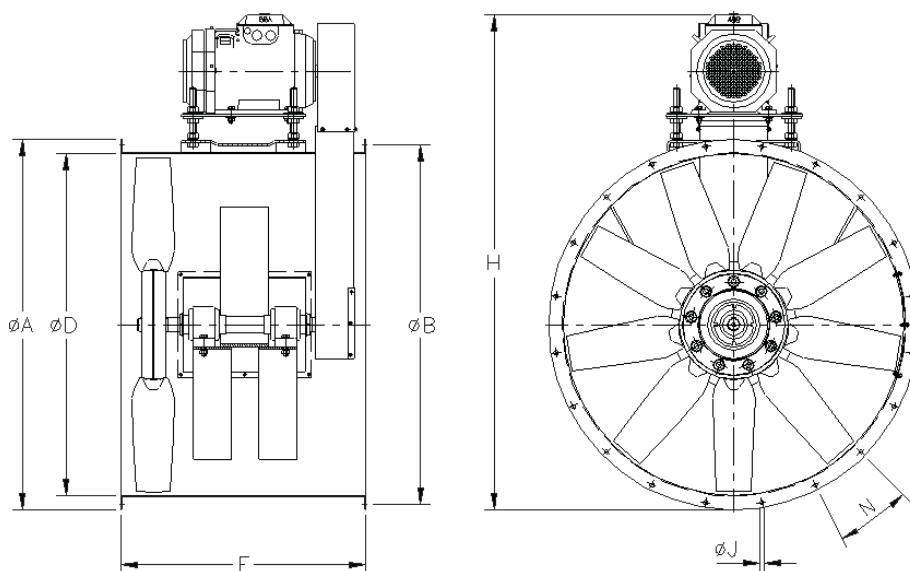

Typ	Ø A	Ø B	Ø D	E	H (kolla motor storlek)						Ø J	N
					132	160	180	200	225	250		
HGT-X-125	1365	1320	1250	900	1743	1815	1850	-	-	-	15	20x18°
HGT-X-125	1365	1320	1250	960	-	-	-	1930	1995	-	15	20x18°
HGT-X-125	1365	1320	1250	1100	-	-	-	-	-	2060	15	20x18°

## Motor storlek

Poler	Varvtal r/min	H.P.													
		3	4	5,5	7,5	10	15	20	25	30	40	50	60	75	100
4T	1500	-	-	-	-	132	160	160	180	180	200	225	225	250	280
6T	1000	-	132	132	132	160	160	180	200	200	225	250	280	280	280
8T	700	132	132	160	160	160	180	200	225	225	250	-	-	-	-

## Tillbehör

Typ	Inloppskona PV	Skyddsgaller RT	In & utstos BTUB	Elastisk stös med flänsar BAC	Monteringsstöd PS
HGT-125 / HGT-X-125	PV-1250	RT-125	BTUB-1250	BAC-1250	PS-125
HGT-140	PV-1400	-	-	-	-
HGT-160	PV-1600	-	-	-	-

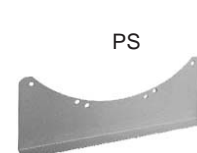
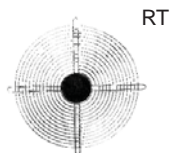

## Flödesdiagram

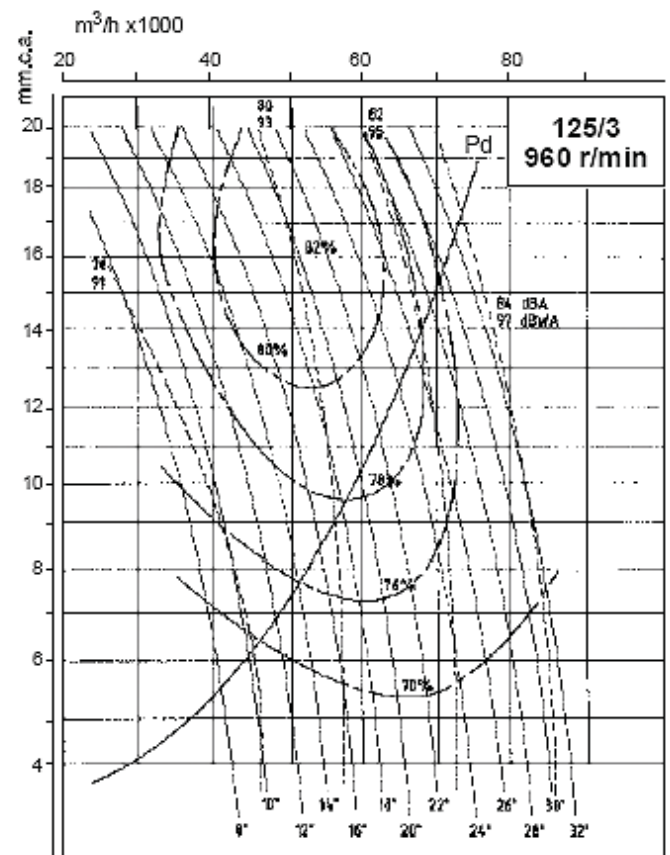
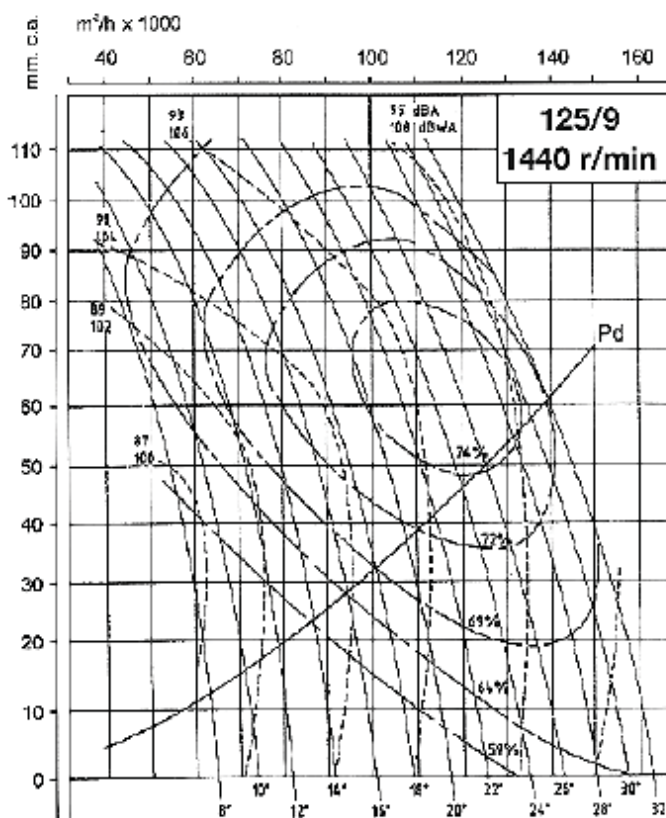
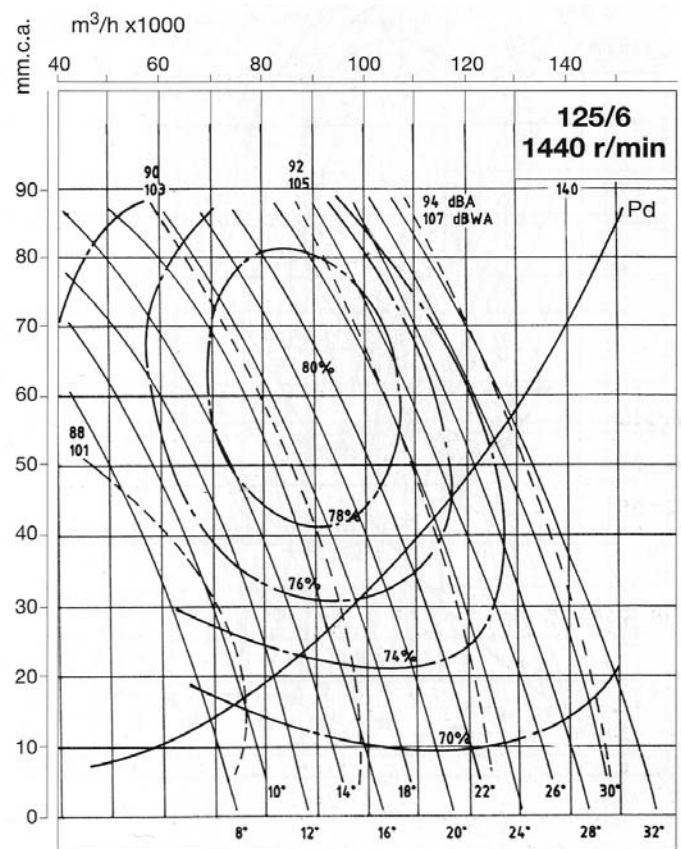
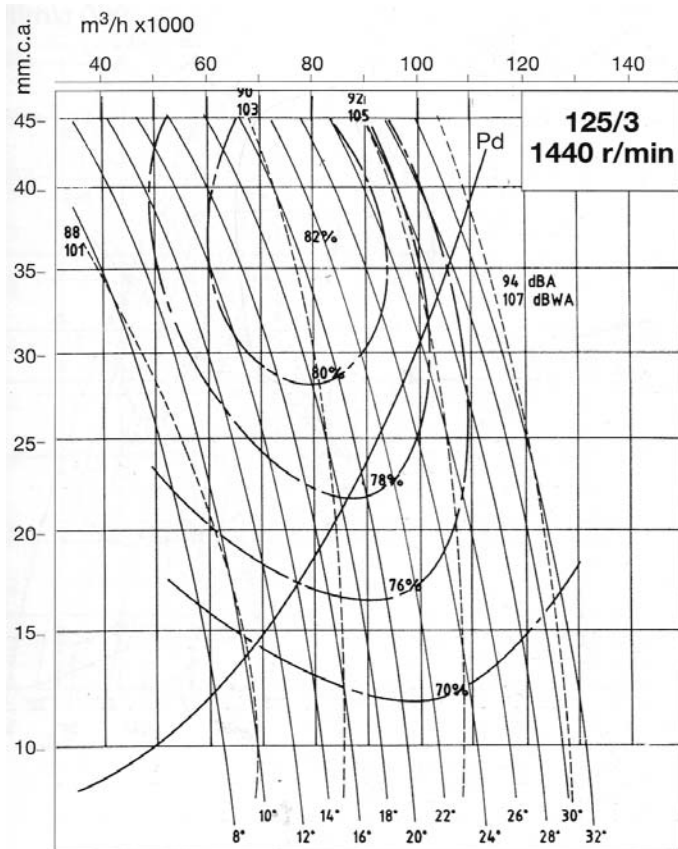

# Kanalfäktar HGT, HGT-X



## Flödesdiagram

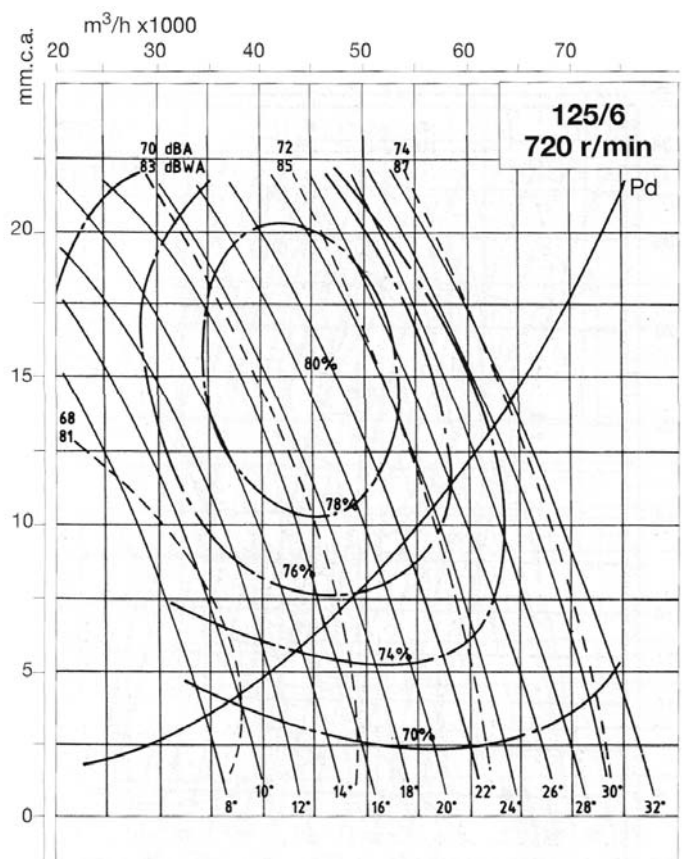
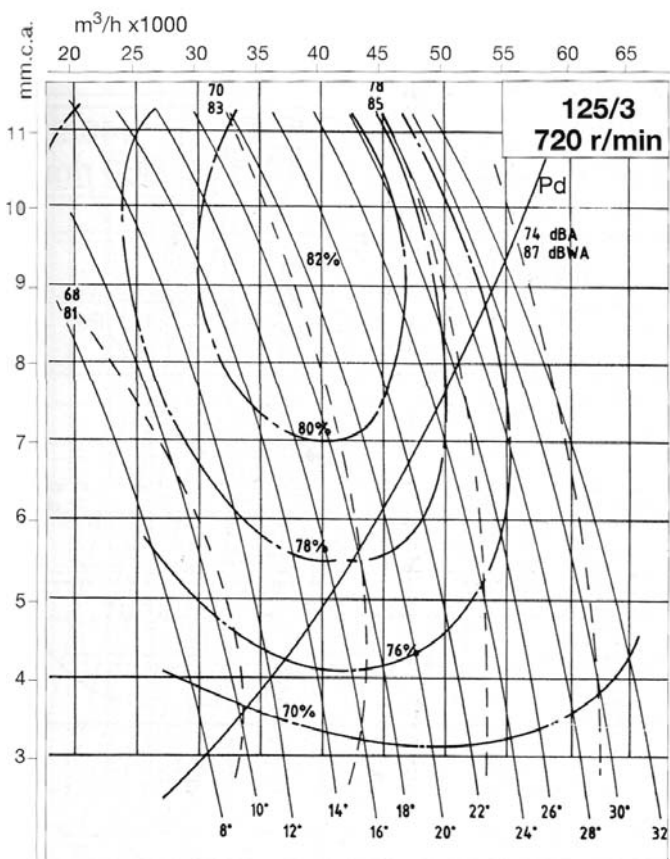
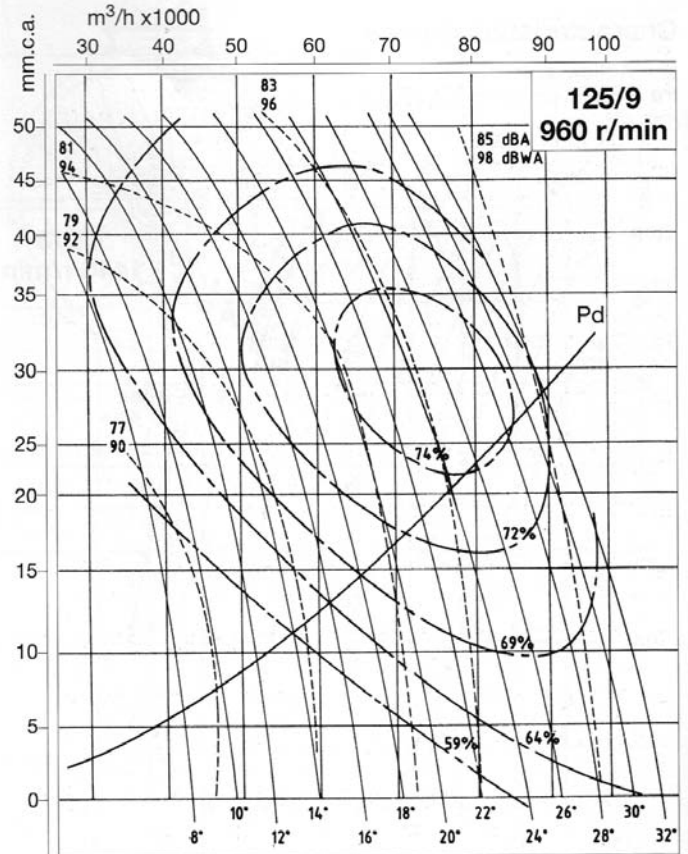
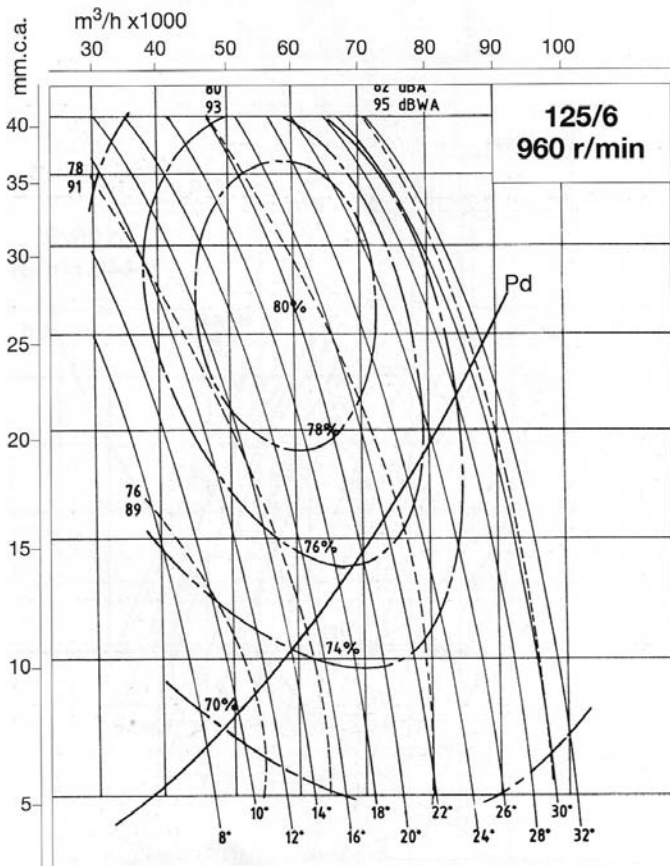

## Flödesdiagram

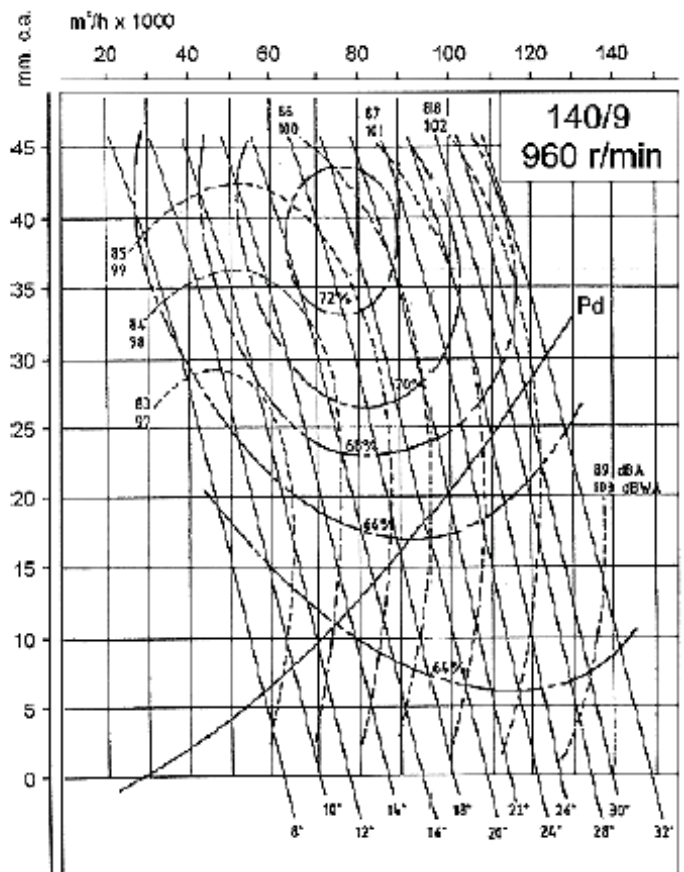
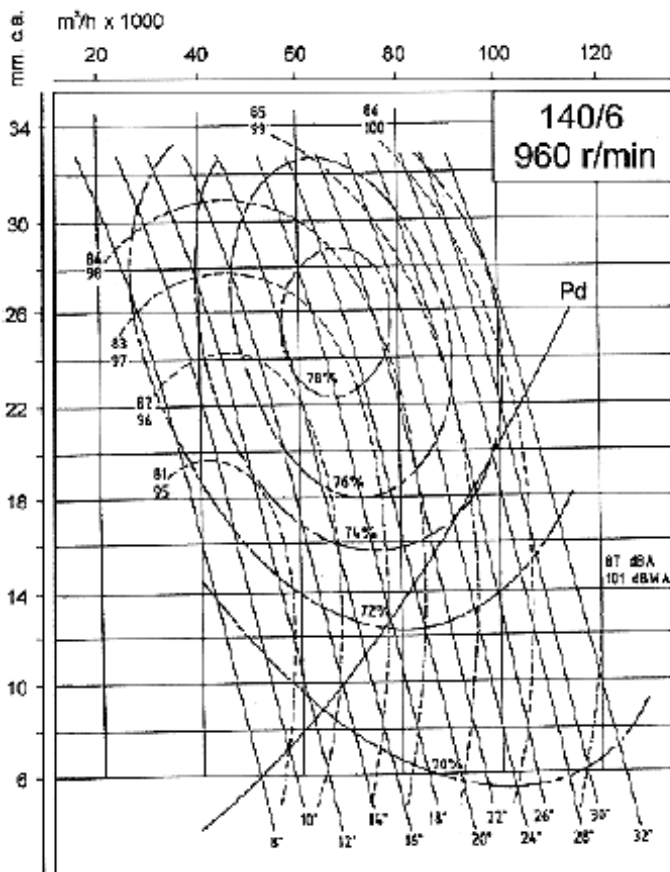
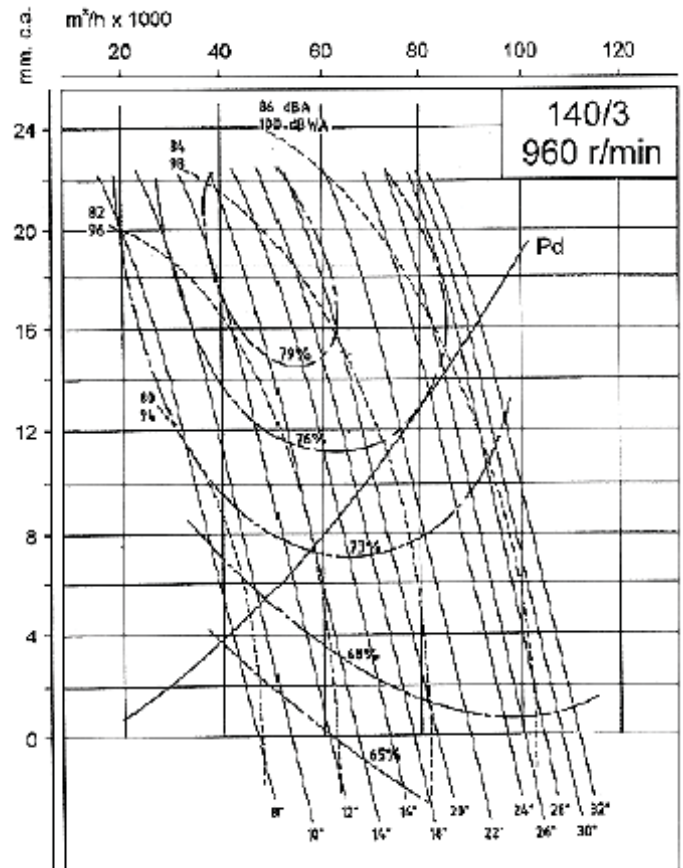
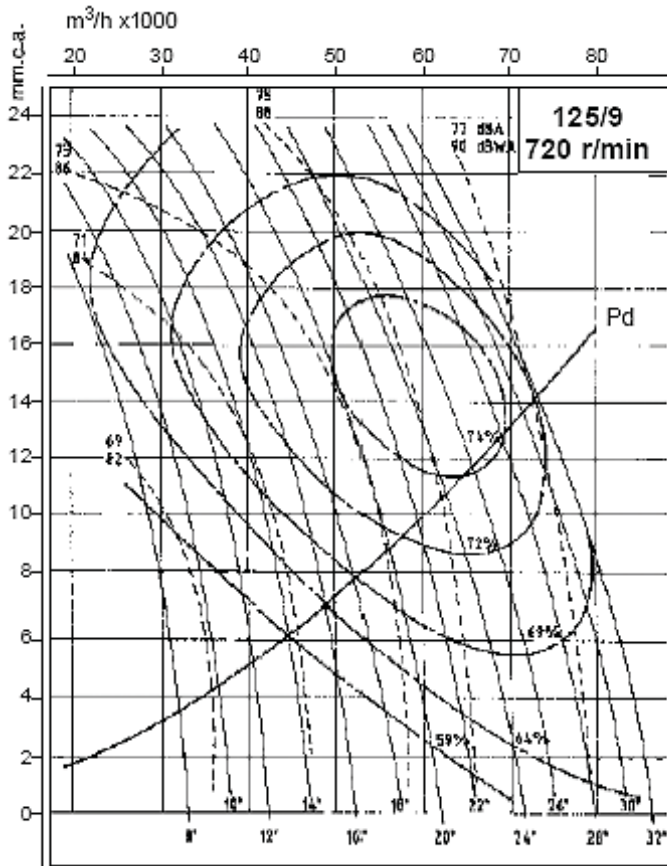

# Kanalfläktar HGT, HGT-X



## Flödesdiagram

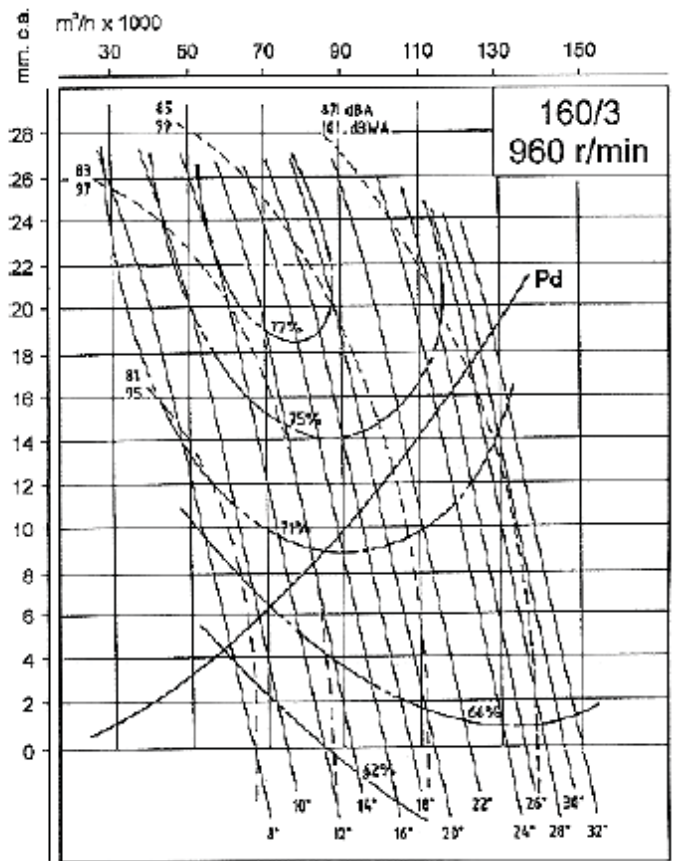
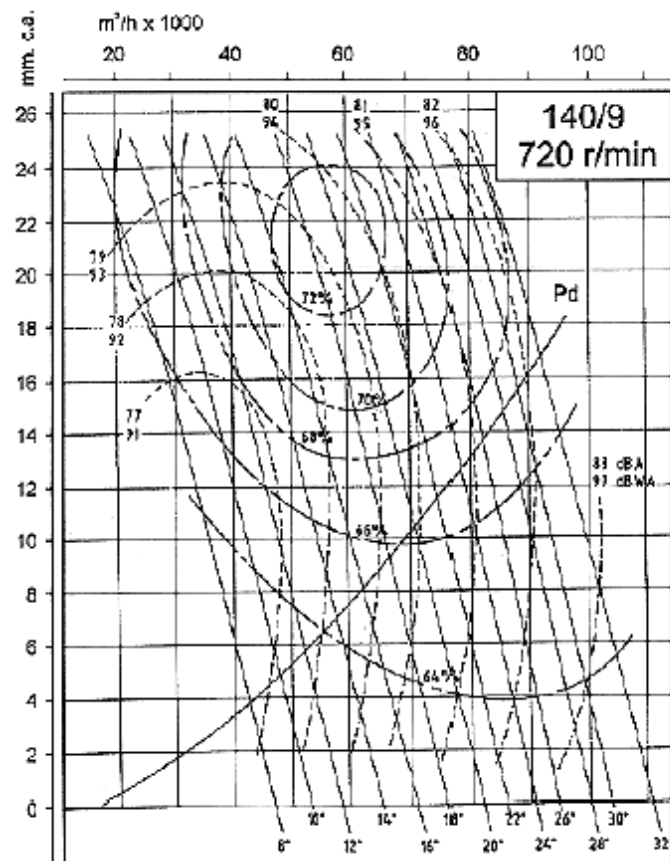
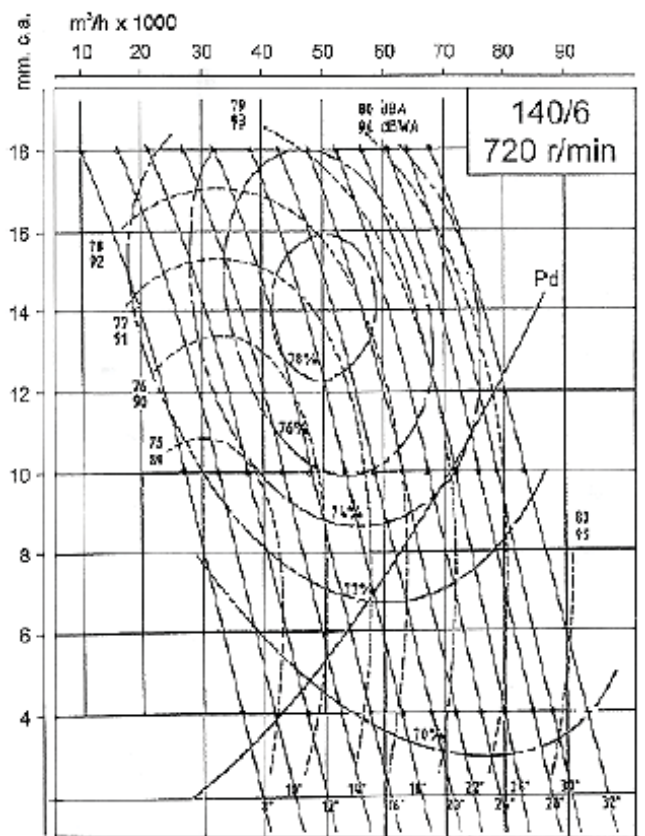
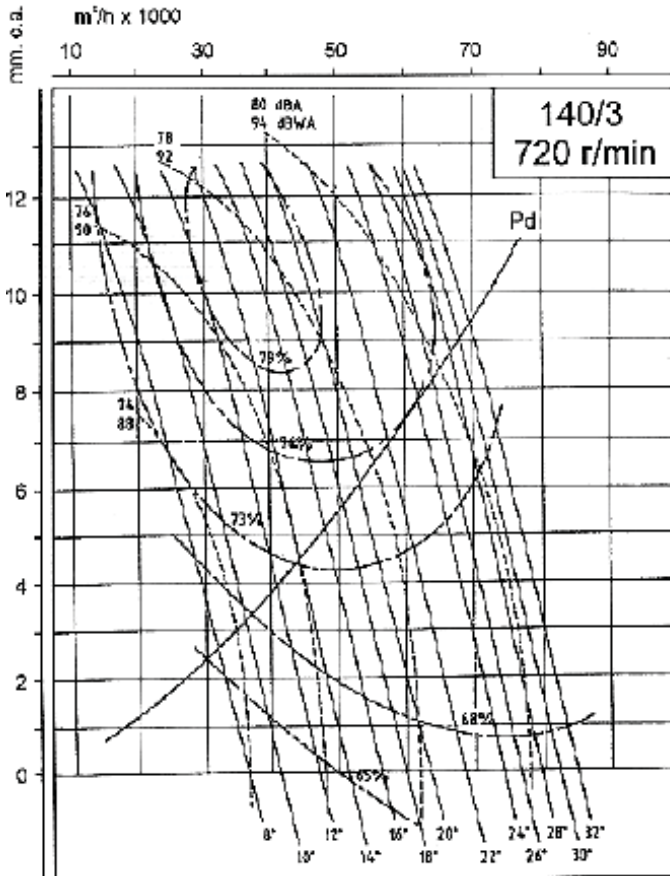

## Flödesdiagram

