

Fläkthus i förzinkad stålplåt med fläns-anslutningar. 8-bladig fläktvinge av glasfiberförstärkt polyamid. Dynamiskt balanserade. Typ EZR med enfas, 230V/50Hz motor med termiskt överbelastningsskydd. Kondensatormotor med driftskondensator i kopplingsbox. Typ DZR med trefas, 400V/50Hz asynkronmotor med termiskt överbelastningsskydd. Potentialfria kabelanslutningar som måste anslutas till motorskydd MV 25 eller kontaktor. 2-hastighetsfläktarna ska kopplas till ett motorskydd som förhindrar överbelastning. Varvtalsförhållandena 12/6, 8/4 och 4/2 har Dahlander-koppling. Varvtalsförhållandena 8/6 och 6/4 har separata lindningar. Skyddsklass IP 55 (EZR 25/4D, DZR 25/4D har IP 54). Isolationsklass B och F. Max. lufttransporttemperatur är + 60° C (DZR 25/4D, DZR 35/84B, EZR 40/6B, EZR 40/4B, DZR 60/84B har annan. Fråga oss). Fläktarna kan monteras horisontellt eller vertikalt och är reversibla (Vid reversering ger fläktarna ca 35 % mindre luftflöde). På förfrågan: i olika spänningar, enfas motor med termisk kontakt eller PTC termistor, kondensdränering, med förhöjt korrosionsskydd, med aluminium fläktvinge.



Teknisk data

Typ	Max.flöde m³/h	Max.tryck Pa	Ex.arb.punkt m³/h - Pa	Varvtal r/min	Max.effekt W		Max.ström Amp		Ljud dB (A)	Vikt kg
					EZR	DZR	EZR	DZR		
EZR/DZR 20/2 B	1100	80	600 - 40	2850	65	75	0,51	0,25	76	6,7
EZR/DZR 25/4 D	1000	200	600 - 90	1425	32	50	0,19	0,16	61	6,7
EZR/DZR 25/2 B	2100	360	1200 - 120	2850	165	150	1,03	0,5	85	9,3
DZR 25/84 B	1100/500	80/22	750-35/300-10	1425/715	-	80/40	-	0,3/0,1	62/46	8,3
DZR 25/42 B	2100/1100	250/90	1400-110/70-30	2850/1425	-	170/30	-	0,33/0,1	83/62	8,2
EZR/DZR 30/6 B	1200	45	800 - 30	930	59	70	0,32	0,19	59	9,2
EZR/DZR 30/4 B	1800	120	1000 - 50	1425	90	80	0,51	0,33	68	9,4
EZR/DZR 30/2 B	3600	400	2400 - 170	2850	313	325	2,75	1	88	13
DZR 30/84 B	1800/900	100/30	1200-40/500-13	1425/715	-	100/40	-	0,3/0,1	67/56	9,3
DZR 30/64 B	1800/1200	150/80	1900-70/1200-30	1425/930	-	120/90	-	0,4/0,35	69/61	12,6
DZR 30/42 B	3600/1800	400/120	2200-180/1200-50	2850/1425	-	360/60	-	0,95/0,3	89/69	12,6
EZR/DZR 35/6 B	1800	40	1000 - 30	930	65	75	0,35	0,17	61	10,8
EZR/DZR 35/4 B	2800	170	2000 - 60	1425	115	120	0,75	0,38	72	11
DZR 35/2 B	5700	450	4000 - 210	2850	-	630	-	2,4	92	14,4
DZR 35/84 B	2700/1300	120/35	2000-50/800-15	1425/715	-	140/40	-	0,3/0,11	70/56	11
DZR 35/64 B	2800/1800	160/80	1800-70/1000-30	1425/930	-	120/90	-	0,4/0,35	72/63	14,1
DZR 35/42 B	5700/2800	550/150	3800-200/2000-50	2850/1425	-	630/110	-	1,25/0,4	92/74	14,2
EZR/DZR 40/6 B	2600	60	2000 - 30	930	98	110	0,52	0,3	64	13,9
EZR/DZR 40/4 B	4200	200	3000 - 80	1425	229	225	1,37	0,65	75	13,8
DZR 40/2 B	9000	500	7000 - 250	2850	-	1350	-	3,1	96	25,1
DZR 40/84 B	4400/2100	200/55	3000-80/1300-15	1425/715	-	220/40	-	0,55/0,17	78/59	16,3
DZR 40/64 B	4400/3000	200/110	3000-80/2000-40	1425/930	-	210/120	-	0,6/0,35	77/66	16,3
DZR 40/42 B	9000/4400	800/200	5500-300/3000-70	2850/1425	-	1370/230	-	2,3/0,85	97/78	24,6
EZR/DZR 45/6 B	4200	130	3000 - 60	930	190	180	1,1	0,7	77	16,1
EZR/DZR 45/4 B	6300	300	5000 - 70	1425	450	360	2	1,1	85	16,5
EZR 50/8 B	4100	60	3000 - 30	715	110	-	0,65	-	75	19,8
EZR/DZR 50/6 B	5600	160	4000 - 50	930	210	220	1,3	0,8	72	19,9
DZR 50/4 B	8800	300	6000 - 120	1425	-	530	-	1,7	85	19,9
DZR 50/86 B	5500/4000	140/100	3900-60/3000-35	930/715	-	240/140	-	0,85/0,5	74/65	20,7
DZR 50/84 B	9000/4000	150/50	7000-50/3000-20	1425/715	-	650/130	-	1,4/0,5	84/65	25
DZR 50/64 B	9000/6000	300/150	6000-100/4000-50	1425/930	-	570/200	-	1,2/0,6	85/73	26,3
DZR 56/6 B	8500	200	6000 - 80	930	-	360	-	1,2	77	28,2
DZR 56/4 B	12000	400	10000 - 130	1425	-	1050	-	3	88	40,2
DZR 60/6 B	10000	200	6000 - 90	930	-	410	-	1,3	78	30,1
DZR 60/4 B	14000	400	10000 - 180	1425	-	1250	-	3,3	89	41,5
DZR 60/86 B	10000/7500	250/150	7000-80/5000-45	930/715	-	490/280	-	1,5/0,9	87/80	34,6
DZR 60/84 B	15000/7000	500/150	10000-200/4000-50	1425/715	-	1400/240	-	2,80,6	90/70	41

Tillbehör



AS
Jalousilutare



GF
Motfläns



AD
Insugskona



SG
Skyddsgaller



VD
Backspjäll



TYR
Tyristor



TRE
5-stegs trafo



STW
Tyristor/Reverserdon



MLZ
Yttergaller



GS
Motstos



ELA
Dukstos m. fläns



EL
Elastisk stös



FU
Fläktfäste/fot



WP
Polreverserdon



P
Polomkopplare

Mått mm

Typ	A	B	C	D	E	F	G	H	I	K
EZR/DZR 20/	213	240	235	254	7	193	243	150	152	165
EZR/DZR 25/	263	300	286	304	7	255	288	150	178	194
EZR/DZR 30/	313	300	356	380	9	255	292	200	203	221
EZR/DZR 35/	363	320	395	420	9	275	319	224	226	248
EZR/DZR 40/	413	370	438	460	9	325	350	250	249	274
EZR/DZR 45/	458	310	487	510	9	255	385	280	274	297
EZR/DZR 50/	513	370	541	565	9	325	423	315	299	325
DZR 56/	570	400	629	664	14	355	485	370	345	355
DZR 60/	613	400	674	710	11	335	517	400	369	376

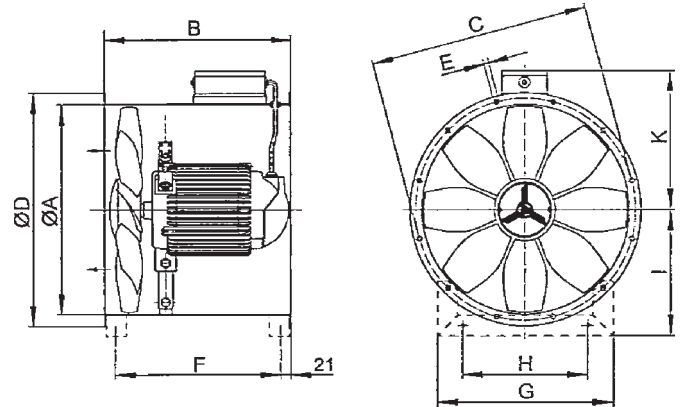

Flödesdiagram

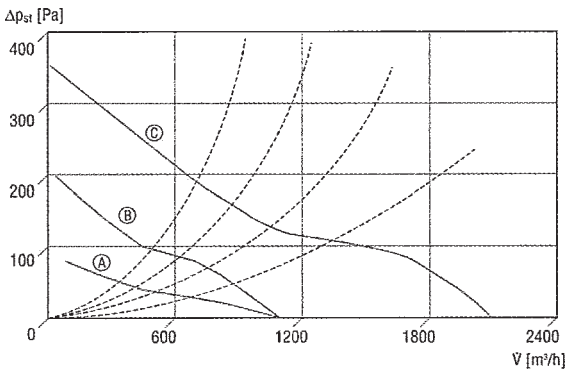

A EZR/DZR 20/2 **B** EZR/DZR 25/4 **D** **C** EZR/DZR 25/2 B

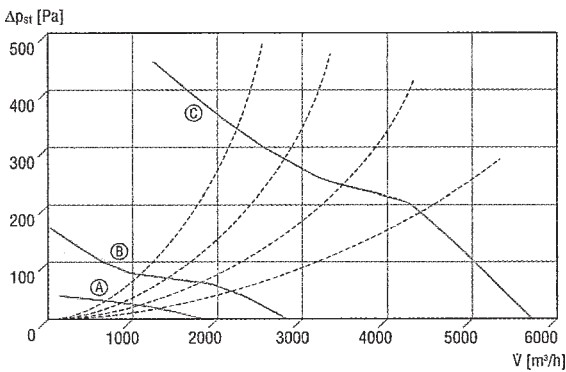

A EZR/DZR 35/6B **B** EZR/DZR 35/4 B **C** DZR 35/2 B

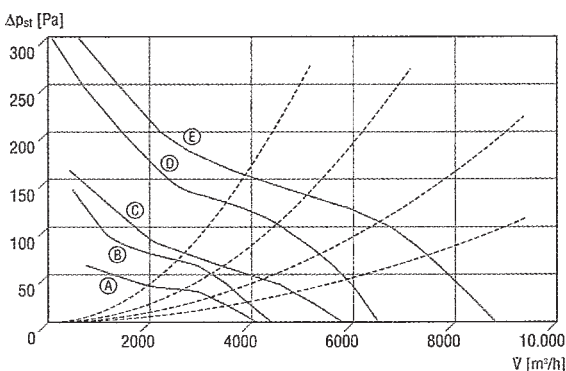

A EZR 50/8 **B** EZR/DZR 45/6 B **C** EZR/DZR 50/6 B
D DZR 45/4 B **E** DZR 50/4 B

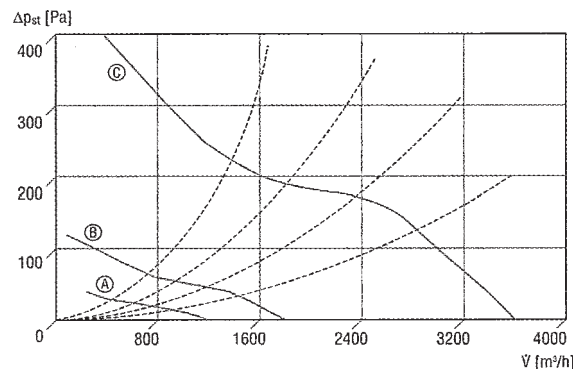

A EZR/DZR 30/6B **B** EZR/DZR 30/4B **C** EZR/DZR 30/2B

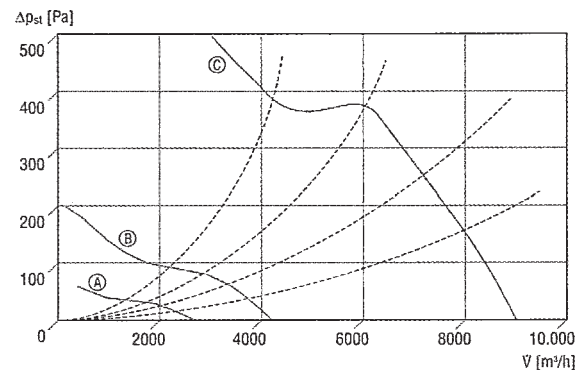

A EZR/DZR 40/6B **B** EZR/DZR 40/4 B **C** DZR 40/2 B

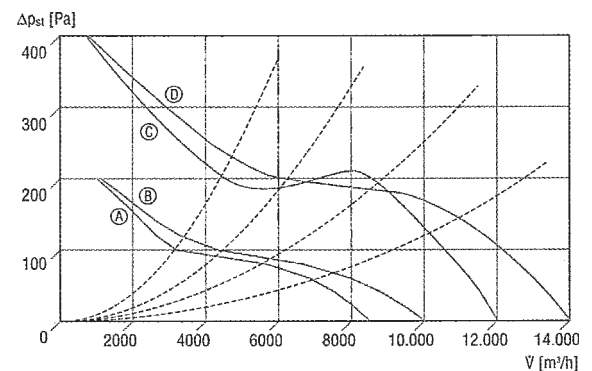

A DZR 56/6 B **B** DZR 60/6 B **C** DZR 56/4 B
D DZR 60/4 B