

EZF / DZF Vägghmonterad fläkt med genomföring**Teknisk data**

- For recessed mounting.
- Can be fitted in any position.
- Wall sleeve made of galvanised sheet-steel.
- 8-blade impellers made of glass-fibre filled polyamide. Dynamically balanced at two levels, in accordance with performance level 6.3, DIN ISO 1940, Part 1.
- Protective grille made of plastic on the intake side, pearl white, protection against accidental contact in accordance with DIN ISO EN 13857.

Air flow direction

- The following illustration shows the air flow direction.

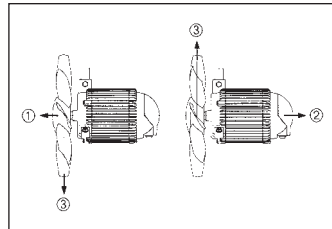

- Air flow direction A: With air drawn across the motor, standard
- Air flow direction B: With air blown across the motor, available on request
- Rotational direction

- Reversing mode: The volumetric flow is reduced by approx. 35 % with abnormal air flow direction.

Motor

- Asynchronous motor.
- Reversible. Exception: Fans with shaded-pole motors (...-E).
- Not suitable for ventilating steam-saturated air.

AC motor

- EZF model series.
- Rated voltage 230 V, 50 Hz.
- Thermal overload protection as a standard feature.
- "../B" fans: Capacitor motors with operating capacitor fitted to protective grille or to wall sleeve. IP 55 degree of protection.
- "../D" fans: Capacitor motors with operating capacitor in terminal box. IP 54 degree of protection.
- "../E" fans: Shaded-pole motors, non reversible. IP 54 degree of protection.

Three-phase AC motor

- DZF model series.
- Rated voltage 400 V, 50 Hz.
- IP 55 degree of protection. Exception DZF... D IP 54.
- Thermal overload protection as a standard feature. Exception: DZF .../D.
- Potential-free terminal connections, which must be connected to e.g. an MV 25 protective motor switch or the control circuit of a contactor.

Electrical connection

- To terminal block under the motor cover.

Safety instructions

- The fan can be operated only if the protection against accidental contact with the impeller is guaranteed to be in accordance with DIN EN ISO 13857 for fans with a free inlet.

Special versions

- The following special versions are available at extra cost on request:
 - Special voltages and frequencies.
 - Single-phase motors with thermal contacts or PTC thermistor, with potential-free terminal connections.
 - Impellers made of aluminium.
- Information on operation at temperatures occasionally below -20°C available upon request.
- If operating with frequency converters, the factory must be consulted.
- Feasibility must be checked in each case.

Technical data for units < 125 W

Article	Art. No.	U _{nom} V	f _{nom} Hz	Air flow volume m ³ /h	Rotating speed 1/min	P _{nom} W	I _{nom} A	I _{max} A	T _{max} at I _{max} °C	Sound power level L _{WA7} dB(A)	Weight kg
DN 200											
EZF 20/4 E	0085.0484	230	50	500	1,380	30	0.23	0.25	60	56	3.3
DN 250											
EZF 25/4 D	0085.0487	230	50	900	1,425	30	0.15	0.18	60	64	4.2
EZF 25/4 E	0085.0486	230	50	800	1,280	40	0.28	0.3	50	59	3.9
DZF 25/4 D	0085.0490	400	50	1,000	1,425	50	0.13	0.14	60	65	3.9
DN 300											
EZF 30/6 B	0085.0053	230	50	1,100	930	60	0.3	0.33	60	60	6.5
EZF 30/4 B	0085.0054	230	50	1,700	1,425	90	0.4	0.5	60	72	6.6
DZF 30/6 B	0085.0101	400	50	1,150	930	70	0.18	0.18	60	60	6.4
DZF 30/4 B	0085.0102	400	50	1,700	1,425	85	0.3	0.33	60	72	6.5
DN 350											
EZF 35/6 B	0085.0055	230	50	1,600	930	70	0.35	0.35	60	64	7.2
EZF 35/4 B	0085.0056	230	50	2,760	1,461	120	0.45	0.75	60	77	7.4
DZF 35/6 B	0085.0103	400	50	1,600	930	80	0.17	0.18	60	63	7.1
DN 400											
EZF 40/6 B	0085.0057	230	50	2,400	930	100	0.45	0.5	55	67	10.4
DZF 40/8 B	0085.0105	400	50	1,900	715	85	0.2	0.2	60	60	9.4
DZF 40/6 B	0085.0106	400	50	2,500	930	120	0.3	0.3	60	67	10.1
DN 500											
EZF 50/8 B	0085.0061	230	50	3,800	715	110	0.5	0.65	60	68	14.8

Technical data for units > 125 W according to ErP in Best Efficiency Point (BEP)

Article	Art. No.	U _{nom} V	f _{nom} Hz	Air flow volume m ³ /h	Sound power level _{WA7} dB(A)	Air volume _{nom} m ³ /h	Pressure p _{fs, nom} Pa	Rotating speed n _{nom} 1/min	P _{nom} W	I _{nom} A	I _{max} A	T _{max} at I _{max} °C	Weight kg	Efficiency level N	Total efficiency η %
DN 350															
DZF 35/4 B	0085.0104	400	50	2,710	78	1,645 ¹⁾	66 ¹⁾	1,465 ¹⁾	135 ¹⁾	0.55 ¹⁾	0.6	60	10.6	40.7	28.8
DN 400															
EZF 40/4 B	0085.0058	230	50	4,170	80	2,820 ¹⁾	78 ¹⁾	1,410 ¹⁾	230 ¹⁾	0.95 ¹⁾	1.6	60	10.6	41.1	30.7
DZF 40/4 B	0085.0107	400	50	4,200	81	2,640 ¹⁾	87 ¹⁾	1,440 ¹⁾	230 ¹⁾	0.6 ¹⁾	0.75	60	13	42.7	32.4
DN 450															
DZF 45/6 B	0085.0108	400	50	4,220	76	2,910 ¹⁾	53 ¹⁾	985 ¹⁾	170 ¹⁾	0.55 ¹⁾	0.6	60	19.4	40.5	29.2
DZF 45/4 B	0085.0109	400	50	6,045	85	3,970 ¹⁾	116 ¹⁾	1,380 ¹⁾	455 ¹⁾	0.8 ¹⁾	1.1	60	14.4	40.6	32.1
DN 500															
DZF 50/6 B	0085.0111	400	50	5,480	78	3,300 ¹⁾	67 ¹⁾	975 ¹⁾	220 ¹⁾	0.6 ¹⁾	0.7	60	20.4	42.9	32.5

¹⁾ In opt. efficiency

BEP measured in measurement category A, static efficiency category. Calculation of energy efficiency without protective grille.

Dimensions [mm]

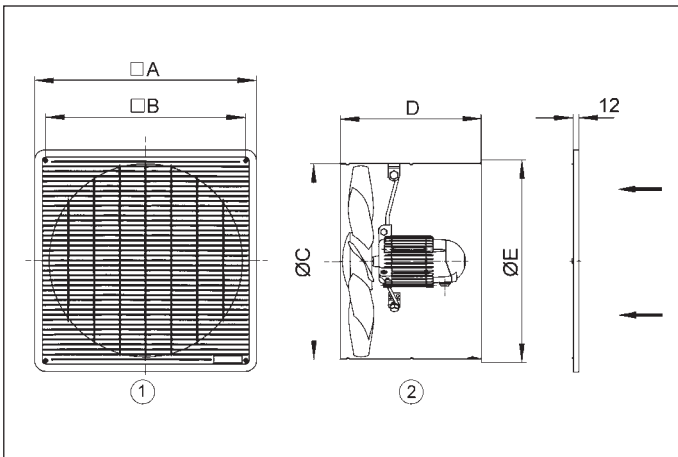

- ① Protective grille on intake side
- ② Air flow direction with air drawn across the motor

Nominal size	A	B	C	D	E
DN 200	258	212	216	240	-
DN 250	320	274	266	240	280
DN 300	365	319	316	300	330
DN 350	428	382	366	300	380
DN 400	470	424	416	300	430
DN 450	580	534	460	315	475
DN 500	580	534	517	315	530

EZF / DZF wall-mounted fan with wall sleeve

Characteristic curves for DN 200 and DN 250

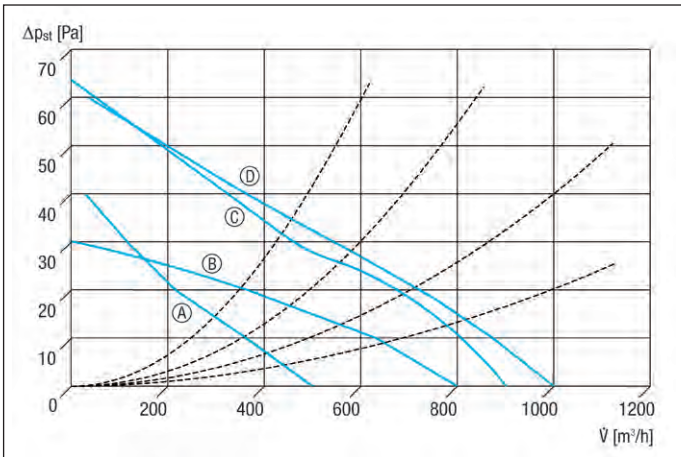

- Ⓐ EZF 20/4 E
- Ⓑ EZF 25/4 E
- Ⓒ EZF 25/4 D
- Ⓓ DZF 25/4 D

Characteristic curves for DN 300

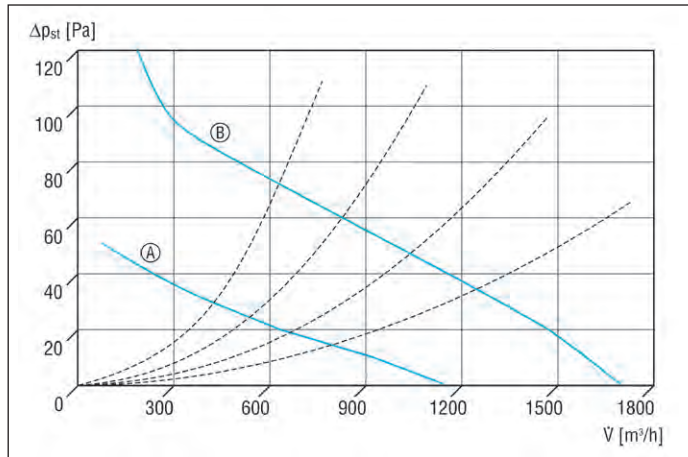

- Ⓐ EZF, DZF 30/6 B
- Ⓑ EZF, DZF 30/4 B

Characteristic curves for DN 350

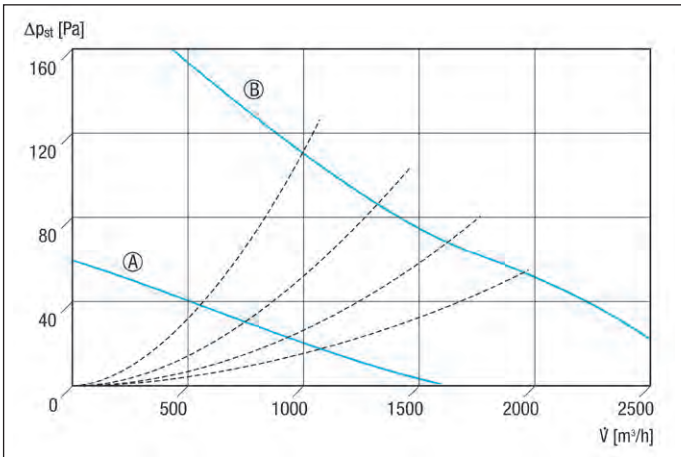

- Ⓐ EZF, DZF 35/6 B
- Ⓑ EZF, DZF 35/4 B

Characteristic curves for DN 400

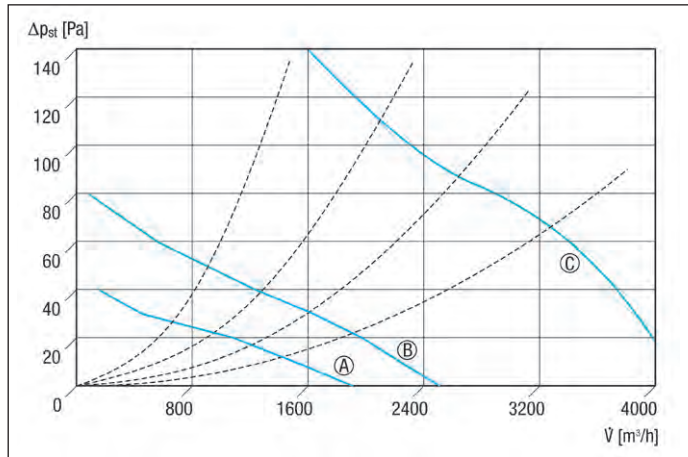

- Ⓐ DZF 40/8 B
- Ⓑ EZF, DZF 40/6 B
- Ⓒ EZF, DZF 40/4 B

Characteristic curves for DN 450

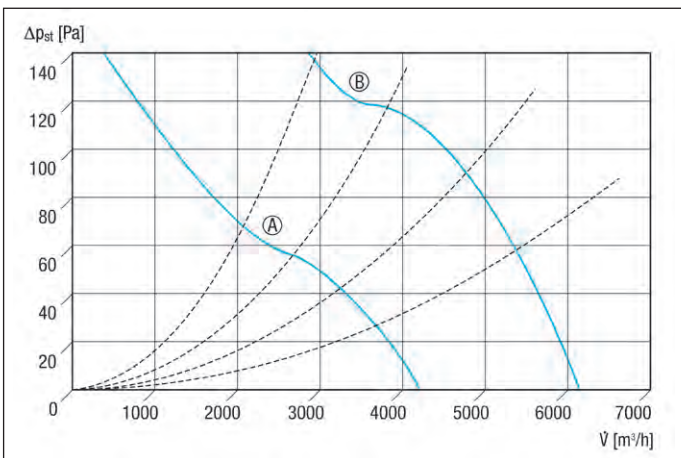

- Ⓐ DZF 45/6 B
- Ⓑ DZF 45/4 B

Characteristic curves for DN 500

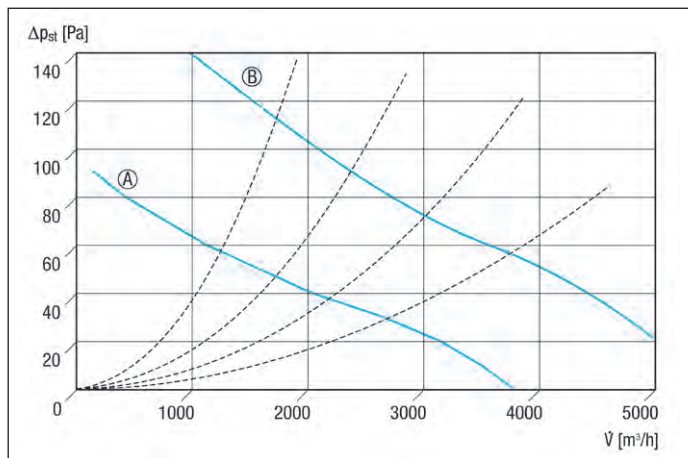

- Ⓐ EZF 50/8 B
- Ⓑ DZF 50/6 B

Tillbehörstabell

	EZF 20/4 E	EZF 25/4 D	EZF 25/4 E	DZF 25/4 D	EZF 30/6 B	EZF 30/4 B	DZF 30/6 B	see
General accessories								
Shutter	AS 20	AS 25	AS 25	AS 25	AS 30	AS 30	AS 30	P. 297
Shutter, manual	RS 20	RS 25	RS 25	RS 25	RS 30	RS 30	RS 30	P. 299
External grille	MLA 20 MLZ 20	MLA 25 MLZ 25	MLA 25 MLZ 25	MLA 25 MLZ 25	MLA 30 MLZ 30	MLA 30 MLZ 30	MLA 30 MLZ 30	P. 305
Extension sleeve	VH 20	VH 25	VH 25	VH 25	VH 30	VH 30	VH 30	P. 206
Air filter	ZFF 20	ZFF 30	ZFF 30	ZFF 30	ZFF 30	ZFF 30	ZFF 30	P. 207
Reversing switch	-	W 1 WU 1	-	-	W 1 WU 1	W 1 WU 1	W 1 WU 1	P. 334
Speed controller	ST 1 STU 1	ST 1 STU 1	ST 1 STU 1	-	ST 1 STU 1	ST 1 STU 1	-	P. 338
Speed controller, reversing switch	-	STW 1	-	-	STW 1	STW 1	-	P. 339
5-step transformer	TRE 0,4-2	TRE 0,4-2	TRE 0,4-2	TR 0,4-2	TRE 0,4-2	TRE 0,6-2	TR 0,4-2	P. 340
5-step transformer, control cabinet	TRE 1,6 S-2	TRE 1,6 S-2	TRE 1,6 S-2	TR 0,8 S-2	TRE 1,6 S-2	TRE 1,6 S-2	TR 0,8 S-2	P. 341
5-step switch for TRE...S -2/ TR...S-2 5-step transformer	ESS 20	ESS 20	ESS 20	DSS 20	ESS 20	ESS 20	DSS 20	P. 341
Temperature control system	EAT 6 G/1 EAT 6 TG	EAT 6 G/1 EAT 6 TG	EAT 6 G/1 EAT 6 TG	-	EAT 6 G/1 EAT 6 TG	EAT 6 G/1 EAT 6 TG	-	P. 345

	DZF 30/4 B	EZF 35/6 B	EZF 35/4 B	DZF 35/6 B	DZF 35/4 B	EZF 40/6 B	EZF 40/4 B	see
General accessories								
Shutter	AS 30	AS 35	AS 35	AS 35	AS 35	AS 40	AS 40	P. 297
Shutter, manual	RS 30	RS 35	RS 35	RS 35	RS 35	RS 40	RS 40	P. 299
External grille	MLA 30 MLZ 30	MLA 35 MLZ 35	MLA 35 MLZ 35	MLA 35 MLZ 35	MLA 35 MLZ 35	MLA 40 MLZ 40	MLA 40 MLZ 40	P. 305
Extension sleeve	VH 30	VH 35	VH 35	VH 35	VH 35	VH 40	VH 40	P. 206
Air filter	ZFF 30	ZFF 40	ZFF 40	ZFF 40	ZFF 40	-	-	P. 207
Reversing switch	W 1 WU 1	W 1 WU 1	W 1 WU 1	W 1 WU 1	W 1 WU 1	W 1 WU 1	W 1 WU 1	P. 334
Speed controller	-	ST 1 STU 1	ST 1 STU 1	-	-	ST 1 STU 1	ST 2,5 STU 2,5	P. 338
Speed controller, reversing switch	-	STW 1	STW 1	-	-	STW 1	STW 2,5	P. 339
5-step transformer	TR 0,4-2	TRE 0,4-2	TRE 1,6-2	TR 0,4-2	TR 0,8-2	TRE 0,6-2	TRE 1,6-2	P. 340
5-step transformer, control cabinet	TR 0,8 S-2	TRE 1,6 S-2	TRE 1,6 S-2	TR 0,8 S-2	TR 0,8 S-2	TRE 1,6 S-2	TRE 1,6 S-2	P. 341
5-step switch for TRE...S -2/ TR...S-2 5-step transformer	DSS 20	ESS 20	ESS 20	DSS 20	DSS 20	ESS 20	ESS 20	P. 341
Temperature control system	-	EAT 6 G/1 EAT 6 TG	EAT 6 G/1 EAT 6 TG	-	-	EAT 6 G/1 EAT 6 TG	EAT 6 G/1 EAT 6 TG	P. 345

	DZF 40/8 B	DZF 40/6 B	DZF 40/4 B	DZF 45/6 B	DZF 45/4 B	EZF 50/8 B	DZF 50/6 B	see
General accessories								
Shutter	AS 40	AS 40	AS 40	AS 45	AS 45	AS 50	AS 50	P. 297
Shutter, manual	RS 40	RS 40	RS 40	RS 45	RS 45	RS 50	RS 50	P. 299
External grille	MLA 40 MLZ 40	MLA 40 MLZ 40	MLA 40 MLZ 40	-	-	MLA 50 MLZ 50	MLA 50 MLZ 50	P. 305
Extension sleeve	VH 40	VH 40	VH 40	VH 45	VH 45	VH 50	VH 50	P. 206
Reversing switch	W 1 WU 1	W 1 WU 1	W 1 WU 1	W 1 WU 1	W 1 WU 1	W 1 WU 1	W 1 WU 1	P. 334
Speed controller	-	-	-	-	-	ST 1 STU 1	-	P. 338
Speed controller, reversing switch	-	-	-	-	-	STW 1	-	P. 339
5-step transformer	TR 0,4-2	TR 0,4-2	TR 0,8-2	TR 0,8-2	TR 2,5-2	TRE 1,6-2	TR 0,8-2	P. 340
5-step transformer, control cabinet	TR 0,8 S-2	TR 0,8 S-2	TR 0,8 S-2	TR 0,8 S-2	TR 2,5 S-2	TRE 1,6 S-2	TR 0,8 S-2	P. 341
5-step switch for TRE...S -2/ TR...S-2 5-step transformer	DSS 20	DSS 20	DSS 20	DSS 20	DSS 20	ESS 20	DSS 20	P. 341
Temperature control system	-	-	-	-	-	EAT 6 G/1 EAT 6 TG	-	P. 345